

Nova 3[®] Respirator

Unrivalled Comfort



Nova 3® Respirator

Unrivalled Comfort



The Nova 3® revolutionises the abrasive blasting experience with the world's most comfortable blasting respirator. With breakthrough technology and comfort, the Nova 3 has been designed around the operator's needs to advance their safety and productivity.

Visibility has been at the forefront of the Nova 3 design process. With the unique cassette lens system, you can experience an optically clear field of view at all times. The superior operating window optimises peripheral vision and allows for 30% more downward vision than other respirators on the market.

The ratchet padding system provides a customisable fit and molded side pads absorb sound, protecting against hearing loss. Its unique helmet design distributes weight evenly across your head and shoulders, keeping the center of gravity low, eliminating top heaviness, and relieving you from aches and strains on your neck.

All parts are field replaceable to minimise downtime and the padding system is machine washable for hygiene purposes.

The Nova 3 is certified to the standards below:

CE 2797

UK CA 0086

EN14594:2005 4B
EN12941:1998
+A2:2008 TH3 P R SL
RESPIRATORY PROTECTION

EN397:2012+A1:2012
HARD HAT PROTECTION
IMPACT CLAUSES

EN166:2001 CLASS 1B
EYE & FACE PROTECTION

Boost Productivity

Our cassette lens system enables you easily tear-off the outer lens when your view becomes obstructed, significantly reducing your downtime.



Bellow seal creates a complete barrier to dust and particulates.

Widened perspective provides optimal downward and peripheral field of view.

Tear-off lens system to ensure you always have a clear visor when operating. Cassette lens system available to further increase productivity.

Streamlined air deflection system distributes air across your breathe zone and across the lens to prevent fogging.

Tough helmet shell, manufactured from robust engineering grade nylon offers EN397 certified hard hat protection.

Ratchet system and adjustable moulded side pads to help create a secure, customised fit.

Large, glove sized latch that is easy to locate and use.

Removable visor for efficient lens replacement.

Cape is securely attached with eight snap fasteners.



Nova 3® shown with optional L4™ light.

Nova 3® Respirator - Packages







Unrivalled Comfort



Nova 3 Headtops for Supplied (Compressed) Air

Part #	Description	Certifications
CORE RANGE		
NV3-711-50 	Nova 3 Blast Respirator with Constant Flow Valve <i>Package also includes:</i> <ul style="list-style-type: none"> ■ Constant flow valve ■ Low flow indicator ■ Nylon cape ■ SAR breathing tube. 	EN14594 4B EN166 EN397
CORE RANGE		
NV3-715-50 	Nova 3 Blast Respirator with Climate Control <i>Package also includes:</i> <ul style="list-style-type: none"> ■ C40™ Climate Control Device ■ Low flow indicator ■ Nylon cape ■ SAR breathing tube. 	EN14594 4B EN166 EN397

Nova 3 Accessories







Part #	Description	Certifications
CORE RANGE		
03-502-FR 	C40™ Climate Control Device - CE - FR	EN14594
03-102 	Constant Flow Valve Assembly - CE	EN14594
07-701 	RPB® Leather Gloves	
07-755-S	RPB® Heavy Duty Blast Suit - Small	
07-755-M 	RPB® Heavy Duty Blast Suit - Medium	
07-755-L	RPB® Heavy Duty Blast Suit - Large	
07-755-XL	RPB® Heavy Duty Blast Suit - X Large	
07-755-XXL	RPB® Heavy Duty Blast Suit - XX Large	
07-755-XXXL	RPB® Heavy Duty Blast Suit - XXX Large	
07-755-XXXXL	RPB® Heavy Duty Blast Suit - XXXX Large	
07-761 	rpb Knee Pads - pair.	
09-502 	L4™ Blast Light Assembly* <i>- Global power connections.</i>	
09-903 	Nova 3™ Talk™ In-Helmet Communication Upgrade Kit* <i>- radio adaptor sold separately.</i>	

Nova 3[®] Respirator - Parts











Unrivalled Comfort











Nova 3 Consumables

Part #	Description	Certifications
CORE RANGE NV2021B	 SAR Breathing Tube	
CORE RANGE NV3-722	 Inner Lens (pk 10)	
NV3-722-T	 Inner Lens - Tinted (pk 10)	
CORE RANGE NV3-724	 Outer Lens (pk 50)	
CORE RANGE NV3-725	 Tear-off Lens (pk 50)	
CORE RANGE NV3-745	 Cassette Lens (pk 20) <i>- each cassette includes 5x tear-offs and 1x outer lens.</i>	
NV3-746	 Mesh Screen (pk 2)	

Nova Talk Parts

Part #	Description	Certifications
09-913	 Push to Talk Button	
09-916	 R-TEX High Noise Headset <i>- includes PTT, radio not supplied.</i>	
09-930	 Motorola Connection Cable - <i>two-pin.</i>	
09-931	 Motorola Connection Cable - <i>multi-pin.</i>	
09-932	 Motorola Connection Cable - <i>multi-pin.</i>	
09-933	 Kenwood Connection Cable - <i>two-pin.</i>	
09-934	 Motorola Connection Cable - <i>multi-pin.</i>	
09-938	 Cable for VX-261	
09-939	 Cable for Apex Icom IC-F4002	
NV3-733TK	 Nova 3 Talk [™] Side Padding Covers <i>- 5 pairs.</i>	

L4 Light Parts

Part #	Description	Certifications
07-122	 Cable and Hose Clamp	
09-021-EU	 Power Cable - <i>EU.</i>	
09-021-UK	 Power Cable - <i>UK.</i>	
09-512	 L4 [™] Light and Mount Kit <i>- includes 09-520.</i>	
09-520	 Mounting Clip	
09-522	 Outer Lens (pk 10)	
09-525	 Battery Charger <i>- Power Cable not included.</i>	
09-532-2	 Battery Pack	

Nova 3® Respirator - Parts



Nova 3 Parts

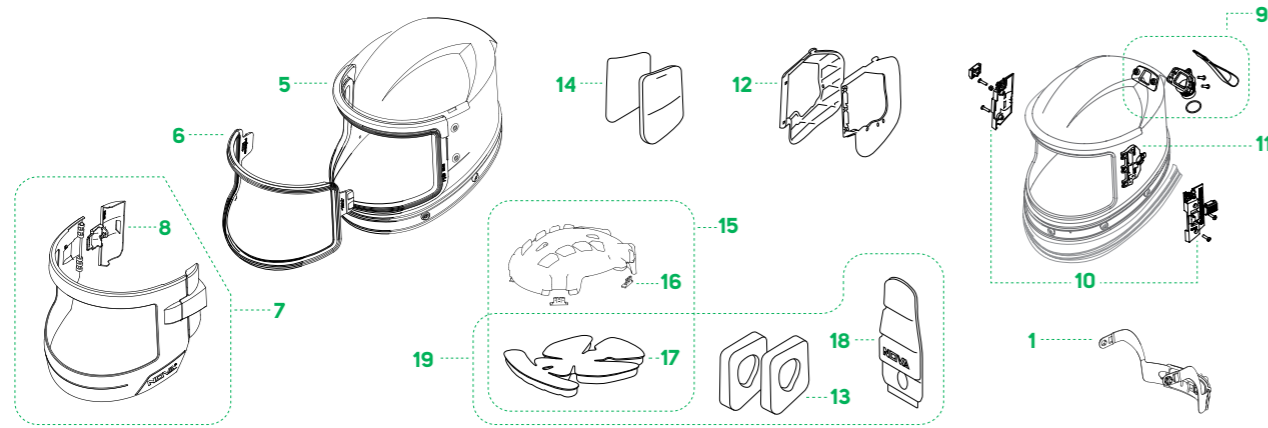

Part # / Description	Part # / Description
1  07-900 Adjustable Head Support	14  NV3-733 Side Padding Covers - 5 pairs.
-  NV2012 Inner Bib	15  NV3-734 Head Liner Kit - includes NV3-734-1.
-  NV2030 Low Flow Indicator Assembly	16  NV3-734-1 Head Liner Clips (pk 4)
-  NV2041 Domes - 8 sets.	17  NV3-735 Head Liner Foam Padding
5  NV3-721 Inner Gasket	18  NV3-735-1 Neck Pad
6  NV3-723 Inner Lens Frame	19  NV3-736- (A05, A10, A15 or A20) Hygiene Kit - available in 5mm, 10mm, 15mm or 20mm.
7  NV3-726 Visor Kit - includes hinge and latch.	-  NV3-750 Nylon Respirator Cape*
-  NV3-727/8 Visor Mount Kit - includes 4pcs FS-40 nuts and 4pcs FS-46 screws.	-  NV3-751 Extra Length Nylon Respirator Cape*
8  NV3-727-2 Hinge Lock	-  NV3-752 Leather Respirator Cape*
9  NV3-729 Air Inlet Kit	-  NV3-753-HD Extra Length, Heavy Duty Leather Respirator Cape*
-  NV3-729-2 Low Flow Indicator Adapter	-  NV3-754 Blast Jacket, Size XL*
11  NV3-730 Padding Connectors - pair.	-  NV3-755 Blast Jacket, Size XXL*
12  NV3-731 Side Padding Frames - pair.	-  NV3-759 Cape Cover Band
13  NV3-732- (A05, A10, A15 or A20) Side Padding Foam & Covers - available in 5mm, 10mm, 15mm or 20mm.	

*Includes NV2012 Inner Bib.



Astro™ Respirator

The Economic Blasting Choice



The Astro™ is the undisputed economic champion of the abrasive blasting world. Meeting safety standards worldwide, including Australia, Europe, and the USA, this classic flat lens design is part of our design DNA.

Productivity is always at the forefront of our engineers' minds when designing our range. Incorporating our tear-off lens system saves you up to 45 minutes per day and ensures your visibility is never compromised. Weighing just 1.2kgs (excluding breathing tube), the Astro's lightweight design helps to reduce fatigue, and minimises aches and strains on your neck and shoulders.

The Astro offers low lifetime maintenance and part replacement costs, offering you unbeatable value and return on investment without compromising your safety.

The Astro is certified to the standards below:

CE 2797

UK CA 0086

EN14594:2005 4B
RESPIRATORY PROTECTION

Boost Productivity

Operators have reported a time saving of over 45 minutes per day per blaster by using our tear-off lenses. With individually pre-folded tabs, this system guarantees only one lens will be removed at a time.



Removable head suspension allows for easy cleaning.

Manufactured from robust U.V stabilised and abrasive resistant material.

Sturdy visor frame with moulded hinge.

Large visor lens for widened field of view.

Cape is securely attached with 8 stud domes.

Hand strap for easy transportation and storage.

Streamlined air distribution system supports air movement across your breathe zone and over the lens to prevent fogging.

Optional tear-off lenses are available.

Unique, high-strength visor strap.



Astro™ Respirator - Packages

The Economic Blasting Choice



Astro Headtop

Part #	Description	Certifications
CORE RANGE 02-800-CE	 <p>Astro Blast Respirator with Constant Flow Valve <i>Package also includes:</i> ■ Constant flow valve ■ Low flow indicator ■ Nylon cape ■ SAR breathing tube.</p>	EN14594 4B

Astro Consumables

Part #	Description	Certifications
CORE RANGE 02-810	 <p>Inner Lens (pk 10)</p>	
02-810-T	 <p>Inner Lens - Tinted (pk 10)</p>	
CORE RANGE 02-811-015	 <p>Outer Lens (pk 50)</p>	
CORE RANGE 02-816	 <p>Tear-off Lens (pk 50)</p>	
CORE RANGE NV2021B	 <p>SAR Breathing Tube</p>	









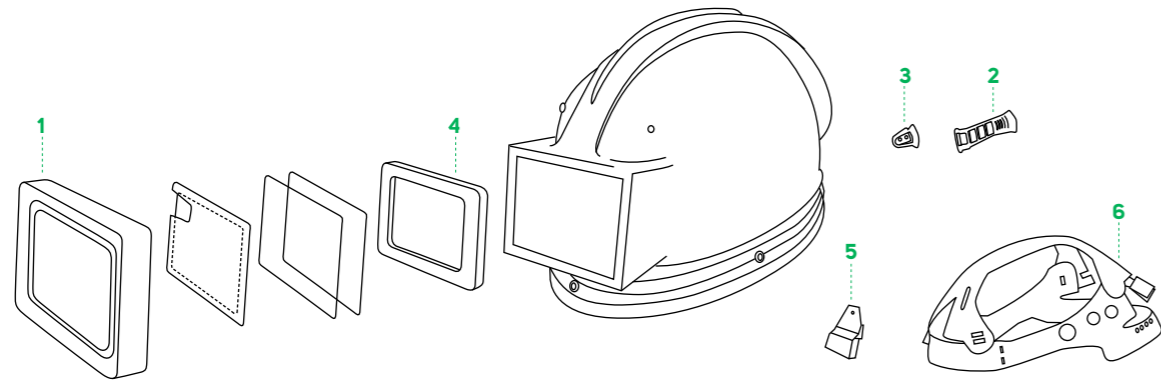



Astro™ Respirator - Parts

The Economic Blasting Choice



Astro Parts



Part # / Description	Part # / Description
1  02-804 Visor Kit - includes 02-805 and screws.	-  02-813 Nylon Respirator Cape
3  02-806 Cleat and Screws	-  02-814 Leather Respirator Cape
4  02-807 Window Gasket Seal	-  03-035 Air Inlet Assembly
5  02-808 Head Suspension Clips - pk 4.	-  NV2012 Inner Bib
6  02-809CE Head Harness	-  NV2030 Low Flow Indicator Assembly
-  02-812 Cape Cover Band	-  NV2041 Domes - 8 sets.
	-  NV2042 Hand Strap



Radex® Airline Filter

Advanced Filtration Capacity



The RPB Radex Airline Filter improves the quality of the air you are breathing. Exceeding industry filtration standards, the Radex gives you the confidence that you won't be breathing contaminated air known to lead to major health issues. With the Radex, it's our commitment to protect you for life's best moments.

The Radex is fitted with a large capacity, 6-stage filter cartridge that removes moisture, odor and particulates to 0.5 micron from the compressed air stream, providing clean, breathable air. With a unique twist-and-lock wall and floor mounting system, the Radex is adaptable to all workplaces.

An optional auto drain valve is available to fit to your filter that continually removes moisture from the filter housing, increasing the lifespan of the filter cartridge.

Quick disconnect coupler that is compatible with brands including Aro, CEJN, Dixon and Rectus.

150 psi safety pressure relief valve.

Outlet pressure regulator provides the ability to adjust air pressure. Range 0-125 psi (04-900 2 outlet unit only).

Claw coupler port (optional).

Replacement filter cartridges have a replacement date sticker for maintenance scheduling.

Strong, robust housing.

Wall and floor mounting system.

Fitted with brass drain tap.



6 OUTLET System

Upgrade to the 6-outlet system to provide filtration to six separate airlines from one filter.



Radex® Airline Filter

Advanced Filtration Capacity



The Radex® airline filter is a large 6-stage filtration system that removes moisture, odour, and particulates from the compressed air-stream.



Radex Airline Filter Parts

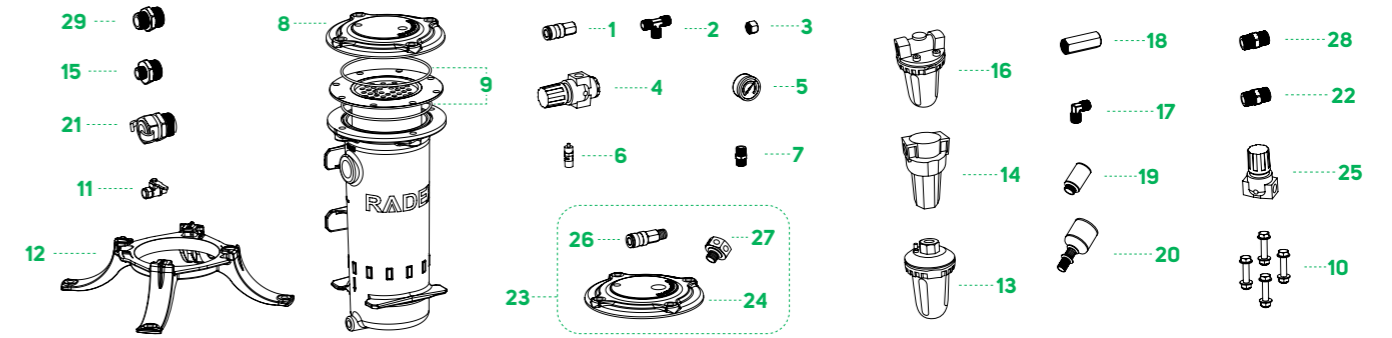

Part # / Description	Part # / Description
1 04-911 1/4 Inch Coupler 3/8 Inch Female Thread	16 04-927 Mainline Pre-filter
2 04-912 3/8 Inch Brass Tee	17 04-928 Brass Elbow
3 04-913 3/8 Inch Brass Cap	18 04-929 Filter Element - for 04-927.
4 04-914 Pressure Regulator	19 04-930 Micro Mist Filter Element - for 04-925.
5 04-915 Pressure Gauge	20 04-931 Auto Drain Assembly - for 04-924.
6 04-916 Pressure Relief Valve	21 04-951 Claw Coupler
7 04-917 3/8 Inch Brass Nipple	22 04-952 1/2 Inch x 1/2 Inch Male NPT Nipple
8 04-918 Filter Lid	23 04-960 Six Outlet Upgrade Kit
9 04-919 O-Ring - set of 2.	24 04-961 Six Outlet Filter Lid
10 04-920 Bolt, Nut, Washer - set of 4.	25 04-962 High Flow Regulator
11 04-922 Brass Drain Tap	26 04-964 1/4 Inch Coupler 3/8 Inch MNPT - to fit 04-965 Manifold.
12 04-923 Base/Wall Mount	27 04-965 6 Outlet Manifold
13 04-924 Auto Drain Unit	28 04-966 1 Inch NPT Hex Connector
14 04-925 Micro Mist Filter 1/2 Inch	29 04-967 1 Inch NPT to 3/4 Inch BSP Bushing
15 04-926 1 Inch x 1/2 Inch Reducing Nipple	

Radex Airline Filter Packages

Part #	Description	Certifications
CORE RANGE 04-900	 Radex Airline Filter - 2 Outlet Package also includes: <ul style="list-style-type: none"> Filter housing Six stage filter cartridge Base/wall mount Pressure regulator and gauge 2x universal couplers. 	
CORE RANGE 04-906	 Radex Airline Filter - 6 Outlet Package also includes: <ul style="list-style-type: none"> Filter housing Six stage filter cartridge Base/wall mount High flow pressure regulator and gauge 6x universal couplers. 	

Radex Airline Filter Packages

Part #	Description	Certifications
CORE RANGE AFC100	 Replacement Filter Cartridge - generic.	
CORE RANGE APF3100	 Radex 6 Stage Filter Cartridge	

C40™ Climate Control Device

Control Your Environment



The GVS C40 is a robust climate control device, designed to give you ultimate comfort when using your GVS supplied air respirator.

Renowned for our design innovation, the C40 pushes respiratory comfort to the next level. The C40 ensures you are protected for life's best moments by maintaining you at your optimum body temperature, so you don't suffer from heat exhaustion or chilling. With its simple sleek design, cool the incoming air by up to 52°F (29°C) or alternatively, heat it by up to 33°F (18°C) all by the slide of a lever. This device is the next step for maximizing your productivity and safety.

CE 2797

UK 0086

EN14594:2005 4B
RESPIRATORY PROTECTION

Low Maintenance

Low maintenance required. The air silencers are the only parts that need cleaning or replacing.



Easily control your temperature with the slide of a lever.

Durable FR or easy clean belt.

Made from lightweight, robust materials - weighs 11.6 ounces (329g), includes belt.

Increase or decrease the airflow by turning the flow control dial.

Choose from a range of plugs to suit your application.

Air inlet swivels 360° to ensure the device sits comfortably on your hip.



C40™ Climate Control Device

Climate Controlled Supplied Air



The flow control range allows the operator to control the flow rate, and temperature of their supplied breathing air when paired with their required SAR headtop.

These devices fit around the user's waist (belt included) and connect the supplied breathing airline to the appropriate SAR respirator (sold separately).



Supplied Air Flow Devices

Part #	Description	Certifications
03-102	Constant Flow Valve Assembly - CE	EN14594
CORE RANGE 03-502	RPB™ C40™ Climate Control Device - CE	EN14594
CORE RANGE 03-502-FR	RPB™ C40™ Climate Control Device - FR	EN14594
NV2016-CE	Flow Control Valve Assembly	EN14594

Supplied Air Breathing Tubes

Part #	Description	Certifications
CORE RANGE 04-833	Breathing Tube - for Z-Link™ and T-Link™.	
CORE RANGE NV2021B	SAR Breathing Tube - for Nova 3™, Nova 2000™ and Astro™.	
CORE RANGE 04-852	Tychem™ Breathing Tube Cover - breathing tube not included.	
CORE RANGE 04-854	FR Breathing Tube Cover - breathing tube not included.	
CORE RANGE 04-855	Aluminized Breathing Tube Cover - breathing tube not included.	
04-856	Disposable/Decon Breathing Tube Sleeve (pk 10) - breathing tube not included.	

Supplied (Compressed) Airline

Part #	Description	Certifications
CORE RANGE 04-322-25	RPB™ 7.5M Breathing Airline Hose - CEJN 342 7,4 mm safety couplers.	EN14594
CORE RANGE 04-322-50	RPB™ 15M Breathing Airline Hose - CEJN 342 7,4 mm safety couplers.	EN14594
CORE RANGE 04-322-100	RPB™ 30M Breathing Airline Hose - CEJN 342 7,4 mm safety couplers.	EN14594

Supplied Air Flow Device Parts

Part #	Description	Certifications
03-022-CF	CEJN Double Action Coupler FNPT	EN14594
03-022-PMS	1/4" Safety Plug to 1/4" NPT Male Swivel	EN14594
4000-12	Temperature Shield	
4000-16	Silencer Disc	
NV2022	1.5" Nylon Belt	
NV2032CE	1/4 Inch Quick Release Plug 1/4 Inch Male Thread	









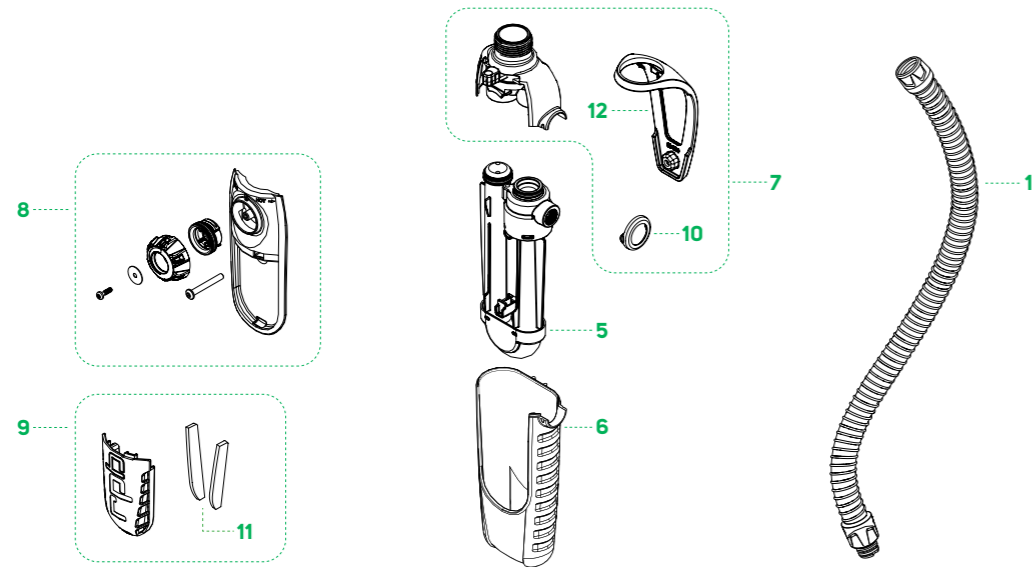

C40™ Climate Control Device

Climate Controlled Supplied Air



C40 Climate Control Device Parts



Part # / Description	Part # / Description
CORE RANGE	
1  04-833 Breathing Tube - for Z-Link™ and T-Link™.	6  03-514 C40™ Bottom Case
CORE RANGE	
-  04-855 Aluminized Breathing Tube Cover - breathing tube not included.	7  03-521 C40™ Top Case Assembly
-  04-856 Clear Breathing Tube Cover (pk 10) - breathing tube not included.	8  03-522 C40™ Exhaust Assembly
-  04-862 C40™ Tychem® Cover	9  03-526 C40™ Silencer Assembly
-  03-022-CF CEJN Double Action Coupler FNPT - NIOSH.	10  03-536 C40™ Inlet Collar
-  03-022-PMS 1/4" Safety Plug to 1/4" NPT Male Swivel - NIOSH.	11  03-537 C40™ Silencers - pair.
5  03-510 C40™ U Tube Assembly	12  03-539 C40™ Belt Loop - 03-521 replacement required for pre-July 2020 C40™.
	-  07-765 2" Belt Assembly
	-  07-765-FR 2" Belt Assembly - FR



GX4® Gas Monitor

Multiple Gas Detection Capabilities



The GVS GX4 Gas Monitor gives you complete confidence that the supplied/compressed air you and your employees breathe is safe. By detecting when there are dangerous levels of toxic gases, this monitor ensures you'll be protected for life's best moments.

Gases such as carbon monoxide are invisible to all the human senses yet are commonly found in industrial premises worldwide. Although low-level exposure may not be immediately fatal, ongoing contact at low levels has a cumulative effect, causing serious illness and long-term health concerns.

The GX4 detects multiple gases simultaneously. With smart device and cloud integration capabilities included this enables you to view your air quality from any device, in real time.

Connect to the GX4 from your laptop, tablet, phone or even network to view real time data, download logs, alter alarm points and much more.



Gas Sensors

Our range of pre-calibrated gas sensors have been updated to fit an improved sensor while incorporating an ergonomic design for simple removal and replacement. Available in CO, O2 and H2S, all with a 2-year shelf life.



Illuminated display that shows real time data.

Complete quick and easy calibration checks with no set points required.

103 DBA staccato alarm.

Monitor up to four gases simultaneously.

Robust power inlet.

Push release air inlet.

Sturdy mounting bracket.

Cartridges can be easily removed and replaced.

Strong nylon ABS case that will handle the harshest of conditions.



GX4® Gas Monitor

Multiple Gas Detection Capabilities



The GX4® Gas Monitor detects up to four gases simultaneously, alerting the user when there are hazardous gases present near the supplied air source. All data and logs can be accessed in real time.



GX4 Gas Monitor Packages

Part #	Description	Certifications
08-400-G	GX4 Gas Monitor - No Sensor Package also includes: ■ Power adaptor pack ■ Mounting brackets ■ Air supply hose.	
08-401	GX4 Gas Monitor - No Sensor with 12 volt Cable with Battery Clips Package also includes: ■ Mounting brackets ■ Air supply hose.	

GX4 Gas Monitor Sensors

Part #	Description	Certifications
08-420-01	Gas Sensor Cartridge - Carbon Monoxide - CO 10ppm	
08-420-02	Gas Sensor Cartridge - Carbon Monoxide - CO 5ppm	
08-420-03	Gas Sensor Cartridge - Hydrogen Sulphide - H2S 10ppm	
08-420-04	Gas Sensor Cartridge - Oxygen - O2 19.5-23%	

GX4 Gas Monitor Accessories

Part #	Description	Certifications
08-231	Wall Bracket	
08-424	Heavy Duty Field Case	
08-434	Auxiliary Cable 15m with Bare End	
08-435	Strobe Light with 15m Cable	
08-436	Auxiliary Strobe & Alarm Tower with 15m Cable	

GX4 Gas Monitor Parts

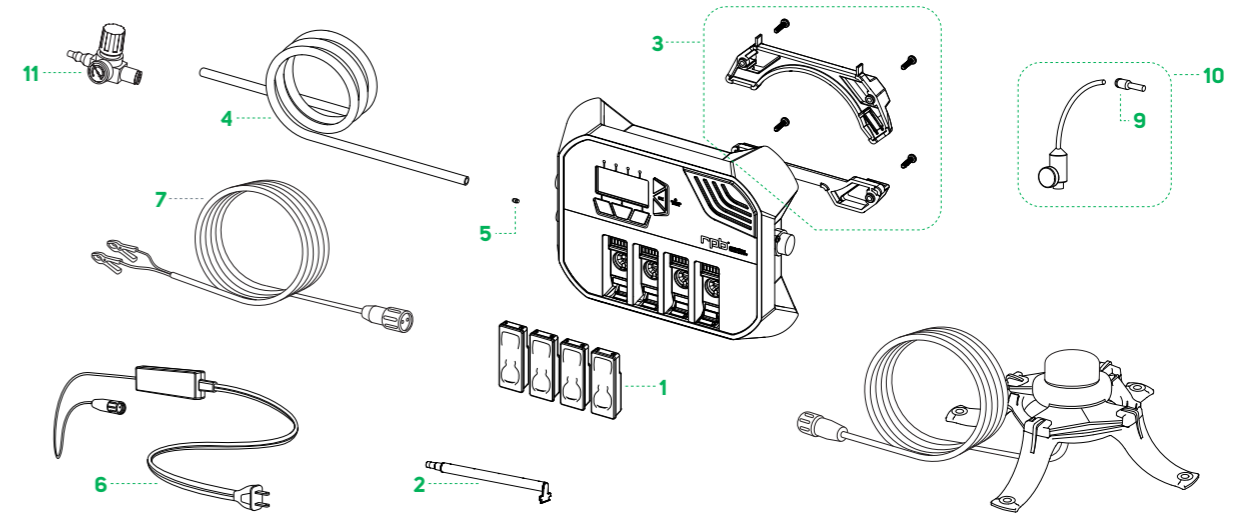

Part # / Description	Part # / Description
1 08-420 Blank Sensor Case	8 08-437 AUX, Field Install Jack
2 08-422 Sensor Manifold Tube	9 08-450 Calibration Adapter
3 08-425 Mounting Bracket - pair, includes screws.	10 08-451 Calibration Flow Regulator - for CO & Zero Air Gas Bottles, includes 08-450.
4 08-428 Air Supply Hose - includes one touch connector.	10 08-452 Calibration Flow Regulator - for H2S Gas Bottles, includes hose and fitting.
5 08-429 M5 Inlet Filter	11 08-470 External Flow Regulator
6 08-430-EU Power Pack Assembly - EU	- 09-021-EU RPB® Power Cable - EU plug
6 08-430-UK Power Pack Assembly - UK	- 09-021-UK RPB® Power Cable - UK plug.
7 08-431 12 Volt Battery Clip & Plug	

Copyright ©2023 GVS S.p.A., All rights reserved.

All materials contained in this publication are protected by United States copyright law and may not be reproduced, distributed, transmitted, displayed, published or broadcast without the prior written permission of GVS S.p.A. You may not alter or remove any trademark, copyright or other notice from copies of the content.

Trademarks and Other Intellectual Property

All trademarks, service marks, and logos used in this publication, both registered and unregistered, are the trademarks, service marks, or logos of their respective owners. The green and gray color combination is a registered trademark of GVS S.p.A.. All rights in the GVS Intellectual Property contained in this publication, including copyright, trademarks, service marks, trade secret, and patent rights are reserved. GVS Intellectual Property means any patent, patented articles, patent applications, designs, industrial designs, copyrights, software, source code, database rights, moral rights, inventions, techniques, technical data, trade secrets, know-how, brands, trademarks, trade names, slogans, logos, and any other common law and proprietary rights, whether registered or unregistered anywhere in the world, that are owned by, developed in whole or in part by, or licensed by GVS S.p.A..

DuPont™ Tychem® is a registered trademark of E.I. du Pont de Nemours and Company or its affiliates.

While the Information contained within this catalog is considered to be true and correct at the date of publication, changes in circumstances after the time of publication may impact on the accuracy of the Information. The Information may change without notice and GVS S.p.A. is not in any way liable for the accuracy of any information printed and stored or in any way interpreted and used by a user.

⚠ WARNING PRODUCT SELECTION

- 1. Determine what type of protection is required for your activity.** As applicable, check your workplace safety program, respiratory protection program, and standards and regulations for your activity or industry.
- 2. Check product specifications.** Contact GVS or check the product instruction manual (downloadable from gvs.com) for complete specifications, including approvals, standards, and regulations to which the product conforms.
- 3. Make sure you have a complete system.** Verify that you have or are purchasing all required components. System requirements are available from GVS or in product instruction manuals.

Selecting inappropriate or incomplete equipment, including the use of counterfeit or non-GVS parts, can result in inadequate protection and will void the certification of the entire respirator.

Want to know more?

Contact us:

Parts are regularly added and updated, and changes occur from time to time.
Contact our team for the latest information.

EUROPE

Italy - Head Office

GVS S.P.A.
Via Roma 50,
40069 Zola Predosa (BO), Italy
Tel. +39-051-617-6311
gvs@gvs.com

United Kingdom

GVS Filter Technology UK Ltd.
NFC House, Vickers Industrial Estate
Mellishaw Lane, Morecambe
Lancashire LA3 3EN
Tel. +44-(0)-1524-847-600
gvsuk@gvs.com

Romania

GVS Microfiltrazione srl
Sat Ciorani de Sus 1E, 107156
Ciorani Prahova România
Tel. +40-244-463044
gvsromania@gvs.com

Turkey

GVS Türkiye
Cevizli mah. Zuhul cad.
Ritim Istanbul no: 44 A-1 Blok D.371
Maltepe / Istanbul
Tel. +90-216-504-4767
gvsturkey@gvs.com

AMERICAS

U.S.A.

GVS-RPB Safety LLC.
2807 Samoset Rd, Royal Oak,
MI 48073, USA
Tel. 1-866-494-4599
respirators@gvs.com

Mexico

Universal No. 550, Vynmsa
Aeropuerto Apodaca Industrial Park,
Ciudad Apodaca, Nuevo León, C.P.
66626, México
Tel. +52-81-2282-9003
gvs_mex@gvs.com

Brazil

GVS do Brasil Ltda.
Rodovia Conego Cyriaco
Scaranello Pires 251
Jd. Progresso, CEP 13190-000
Monte Mor (SP), Brasil
Tel. +55-193-879-7200
gvs@gvs.com.br

Argentina

Av. Rivadavia 13.332 Piso 1 Of. 1001
CP: 1704 Ramos Mejía Buenos Aires
Tel. +54-11-49889041
gvsarg@gvs.com

ASIA-PACIFIC

China

GVS Technology (Suzhou) Co., Ltd.
Fengqiao Civil-Run Sci-Tech Park,
602 Changjiang Road, S.N.D.
Suzhou, China 215129
Tel. +86-512-6661-9880
gvschina@gvs.com

Japan

GVS Japan K.K.
KKD Building 4F, 7-10-12
Nishishinjuku Shinjuku-ku,
Tokyo 160-0023
Tel. +81-3-5937-1447
gvsjapan@gvs.com

Korea

GVS Korea Ltd
#315 Bricks Tower
368 Gyungchun-ro (Gaun-dong),
Namyangju-si, Gyunggi-do,
Tel: +82-31-563-9873
gvs_korea@gvs.com

India

GVS Filter India Pvt Ltd
Unit No 35 & 36 on First Floor
Ratna Jyot Industrial Premises
Irla Lane, Irla Vile Parlae,
Mumbai 400056, India
gvsindia@gvs.com

Malaysia

GVS Filtration Sdn.Bhd
Lot No 10F-2B, 10th Floor, Tower 5 @
PFCC Jalan Puteri 1/2, Bandar Puteri
47100 Puchong, Selangor, Malaysia
Tel: +60-3-7800-0062
gvs_malaysia@gvs.com

Thailand

GVS Thailand
88 Ratchadaphisek Rd,
Office 10E03 - Khlong Toei,
Bangkok 10110
Tel: +66-2-163-4310
gvs_thailand@gvs.com

www.gvs.com

 [linkedin.com/showcase/gvs-health-and-safety](https://www.linkedin.com/showcase/gvs-health-and-safety)

 [youtube.com/gvsrpb](https://www.youtube.com/gvsrpb)

gvs@gvs.com